

marantz®

Model PM4001/PM4001OSE User Guide

Integrated Amplifier

ENGLISH

WARRANTY

For warranty information, contact your local Marantz distributor.

RETAIN YOUR PURCHASE RECEIPT

Your purchase receipt is your permanent record of a valuable purchase. It should be kept in a safe place to be referred to as necessary for insurance purposes or when corresponding with Marantz.

IMPORTANT

When seeking warranty service, it is the responsibility of the consumer to establish proof and date of purchase. Your purchase receipt or invoice is adequate for such proof.

FOR U.K. ONLY

This undertaking is in addition to a consumer's statutory rights and does not affect those rights in any way.

FRANÇAIS

GARANTIE

Pour des informations sur la garantie, contacter le distributeur local Marantz.

CONSERVER L'ATTESTATION D'ACHAT

L'attestation d'achat est la preuve permanente d'un achat de valeur. La conserver en lieu sûr pour s'y reporter aux fins d'obtention d'une couverture d'assurance ou dans le cadre de correspondances avec Marantz.

IMPORTANT

Pour l'obtention d'un service couvert par la garantie, il incombe au client d'établir la preuve de l'achat et d'en corroborer la date. Le reçu ou la facture constituent des preuves suffisantes.

DEUTSCH

GARANTIE

Bei Garantiefragen wenden Sie sich bitte an Ihren Marantz-Händler.

HEBEN SIE IHRE QUITTING GUT AUF

Die Quittung dient Ihnen als bleibende Unterlage für Ihren wertvollen Einkauf. Das Aufbewahren der Quittung ist wichtig, da die darin enthaltenen Angaben für Versicherungswecke oder bei Korrespondenz mit Marantz angeführt werden müssen.

WICHTIG!

Bei Garantiefragen muß der Kunde eine Kaufunterlage mit Kaufdatum vorlegen. Ihren Quittung oder Rechnung ist als Unterlage ausreichend.

NEDERLANDS

GARANTIE

Voor inlichtingen omtrent garantie dient u zich tot uw plaatselijke Marantz.

UW KWITANTIE, KASSABON E.D. BEWAREN

Uw kwitantie, kassabon e.d. vormen uw bewijs van aankoop van een waardevol artikel en dienen op een veilige plaats bewaard te worden voor evt. verwijzing bijv. in verband met verzekering of bij correspondentie met Marantz.

BELANGRIJK

Bij een evt. beroep op de garantie is het de verantwoordelijkheid van de consument een gedateerd bewijs van aankoop te tonen. Uw kassabon of factuur zijn voldoende bewijs.

ESPAÑOL

GARANTIA

Para obtener información acerca de la garantía póngase en contacto con su distribuidor Marantz.

GUARDE SU RECIBO DE COMPRA

Su recibo de compra es su prueba permanente de haber adquirido un aparato de valor. Este recibo deberá guardarlo en un lugar seguro y utilizarlo como referencia cuando tenga que hacer uso del seguro o se ponga en contacto con Marantz.

IMPORTANTE

Cuando solicite el servicio otorgado por la garantía el usuario tiene la responsabilidad de demostrar cuándo efectuó la compra. En este caso, su recibo de compra será la prueba apropiada.

ITALIANO

GARANZIA

L'apparecchio è coperto da una garanzia di buon funzionamento della durata di un anno, o del periodo previsto dalla legge, a partire dalla data di acquisto comprovata da un documento attestante il nominativo del Rivenditore e la data di vendita. La garanzia sarà prestata con la sostituzione o la riparazione gratuita delle parti difettose.

Non sono coperti da garanzia difetti derivanti da uso improprio, errata installazione, manutenzione effettuata da personale non autorizzato o, comunque, da circostanze che non possano riferirsi a difetti di funzionamento dell'apparecchio. Sono inoltre esclusi dalla garanzia gli interventi inerenti l'installazione e l'allacciamento agli impianti di alimentazione.

Gli apparecchi verranno riparati presso i nostri Centri di Assistenza Autorizzati. Le spese ed i rischi di trasporto sono a carico del cliente.

La casa costruttrice declina ogni responsabilità per danni diretti o indiretti provocati dalla inosservanza delle prescrizioni di installazione, uso e manutenzione dettagliate nel presente manuale o per guasti dovuti ad uso continuato a fini professionali.

SVENSKA

GARANTI

För information om garantin, kontakta Marantz lokalagent.

SPAR KVITTOT

Kvittot är ett inköpsbevis på en värdefull vara. Det skall förvaras säkert och hänvisas till vid försäkringsfall eller vidkorrespondens mod Marantz.

VIKTIGT

Fö att garantin skall gälla är det kundens sak att framställa bevis och datum om köpet. Kvitto eller faktura är tillräckligt bevis för detta.

CE MARKING

- CE English**
The PM4001/PM4001OSE is in conformity with the EMC directive and low-voltage directive.
- CE Français**
Le PM4001/PM4001OSE est conforme à la directive EMC et à la directive sur les basses tensions.
- CE Deutsch**
Das Modell PM4001/PM4001OSE entspricht den EMC-Richtlinien und den Richtlinien für Niederspannungsgeräte.
- CE Nederlands**
De PM4001/PM4001OSE voldoet aan de EMC eisen en de vereisten voor laag-voltage.
- CE Español**
El PM4001/PM4001OSE está de acuerdo con las normas EMC y las relacionadas con baja tensión.
- CE Italiano**
Il PM4001/PM4001OSE è conforme alle direttive CEE ed a quelle per i bassi voltaggi.
- CE Svenska**
PM4001/PM4001OSE är tillverkad i enlighet med EMC direktiven och direktiven för lågvoltstrusning.

English

WARNINGS

- Do not expose the equipment to rain or moisture.
- Do not remove the cover from the equipment.
- Do not insert anything into the equipment through the ventilation holes.
- Do not handle the mains cord with wet hands.
- Do not cover the ventilation with any items such as tablecloths, newspapers, curtains, etc.
- No naked flame sources, such as lighted candles, should be placed on the equipment.
- When disposing of used batteries, please comply with governmental regulations or environmental public instruction's rules that apply in your country or area.
- Make a space of about 0.2 meter around the unit.
- No objects filled with liquids, such as vases, shall be placed on the apparatus.
- When the switch is in the OFF position, the equipment is not completely switched off from MAINS.

Français

AVERTISSEMENTS

- Ne pas exposer l'appareil à la pluie ni à l'humidité.
- Ne pas essayer de retirer le boîtier de l'appareil.
- Ne rien insérer dans l'appareil par les orifices de ventilation.
- Ne manipulez pas le cordon d'alimentation avec des mains mouillées.
- Ne pas recouvrir les ouïes de ventilation avec un objet quelconque comme une nappe, un journal, un rideau, etc.
- Ne placer aucune source de flamme nue, comme une bougie allumée, sur l'appareil.
- Pour mettre au rebut les piles usées, respecter les lois gouvernementales ou les règlements officiels concernant l'environnement qui s'appliquent à votre pays ou région.
- Veiller à ce qu'aucun objet ne soit à moins de 0,2 mètre des côtés de l'appareil.
- Aucun objet rempli de liquide, un vase par exemple, ne doit être placé sur l'appareil.
- Lorsque l'interrupteur est sur la position OFF, l'appareil n'est pas complètement déconnecté du SECTEUR (MAINS).

Deutsch

WARNHINWEISE

- Das Gerät nicht Regen oder Feuchtigkeit aussetzen.
- Die Abdeckung nicht vom Gerät abnehmen.
- Keine Gegenstände durch die Belüftungsschlitze stecken.
- Fassen Sie niemals das Netzkabel mit nassen Händen an.
- Decken Sie die Lüftungsöffnungen nicht mit einem Tischtuch, einer Zeitung, einem Vorhang usw. ab.
- Es dürfen keine Gegenstände mit offener Flamme, wie etwa brennende Kerzen, auf dem Gerät aufgestellt werden.
- Beachten Sie bei der Entsorgung der verbrauchten Batterien alle geltenden lokalen und überregionalen Regelungen.
- Auf allen Geräteseiten muß ein Zwischenraum von ungefähr 0,2 meter vorhanden sein.
- Auf das Gerät dürfen keine mit Flüssigkeiten gefüllte Behälter, wie etwa eine Vase, gestellt werden.
- Wenn der Schalter ausgeschaltet ist (OFF-Position), ist das Gerät nicht vollständig vom Stromnetz (MAINS) abgetrennt.

Nederlands

WAARSCHUWINGEN

- Stel het apparaat niet bloot aan regen of vocht.
- Verwijder de afdekplaat van het apparaat niet.
- Duw niets door de ventilatieopeningen in het apparaat.
- Hanteer het netsnoer in geen geval met natte handen.
- Bedek de ventilatieopeningen niet met enige voorwerpen, zoals tafelkleden, kranten, gordijnen, enz.
- Plaats geen brandende voorwerpen, zoals kaarsen, op het apparaat.
- Volg bij het weggooien van verbruikte batterijen de overheidswetgeving of milieuvoorschriften op die van kracht zijn in het land of de regio waarin u zich bevindt.
- Zorg dat er 0,2 meter vrije ruimte rond het toestel is.
- Plaats geen voorwerpen met een vloeistof erin, zoals een bloemenvaas, op het apparaat.
- Als de schakelaar op OFF staat, is het apparaat niet volledig losgekoppeld van de netspanning (MAINS).

Español

ADVERTENCIAS

- No exponga el equipo a la lluvia ni a la humedad.
- No extraiga la tapa del equipo.
- No introduzca nada en el interior del equipo a través de los orificios de ventilación.
- No maneje el cable de la alimentación con las manos mojadas.
- No cubra la ventilación con objetos como manteles, periódicos, cortinas, etc.
- No deben colocarse sobre el equipo elementos con fuego, por ejemplo velas encendidas.
- Cuando se eliminen baterías usadas, deben cumplirse las reglamentaciones oficiales o las normas de protección medioambiental aplicables en su país o en su zona.
- Deje un espacio de unos 0,2 metro alrededor de la unidad.
- No se deben colocar sobre el aparato recipientes que contengan líquidos, como por ejemplo jarrones.
- Cuando el interruptor está en la posición OFF, el equipo no está completamente desconectado de la alimentación MAINS.

Italiano

AVVERTENZE

- Non esporre l'apparecchio alla pioggia o all'umidità.
- Non rimuovere il coperchio dell'apparecchio.
- Non introdurre oggetti all'interno dell'apparecchio attraverso i fori di ventilazione.
- Non toccare il cavo di alimentazione con le mani bagnate.
- Non coprire le fessure di ventilazione con tovaglie, giornali, tende od oggetti analoghi.
- Non posare sull'apparecchio sorgenti di fiamme scoperte quali candele accese.
- Smaltire le pile usate in conformità alle norme governative o disposizioni ambientali vigenti nel proprio paese o zona.
- Lasciare 0,2 metro liberi tutto intorno l'unità.
- Non mettere sull'apparecchiatura alcun contenitore di liquido, come ad esempio dei vasi.
- Quando l'interruttore è nella posizione OFF, l'apparecchiatura non è completamente scollegata da MAINS.

Svenska

VARNINGAR

- Utsätt inte utrustningen för regn eller fukt.
- Ta inte bort utrustningens hölje.
- För inte in föremål i utrustningen genom ventilationshålen.
- Hantera inte nätkabeln med våta händer.
- Täck inte för ventilationsöppningarna med några föremål som till exempel bordsdukar, dagstidningar, gardiner e.d.
- Inga föremål med öppen låga, som till exempel tända stearinljus, bör placeras på utrustningen.
- Följ de lagar och miljöskyddsråd som gäller i det land eller område där du bor när du gör dig av med batterier.
- Se till att det finns omkring 0,2 meter fri plats runt omkring enheten.
- Inga objekt som är fyllda med någon vätska, till exempel blomstervaser, bör placeras på apparaten.
- Även om strömbrytaren står i det avstängda läget OFF, så är utrustningen inte helt bortkopplad från det elektriska nätet (MAINS).

CONTENTS

BEFORE USE	1
CONNECTIONS	2
WIRING SPEAKER CABLE	3
NAMES AND FUNCTIONS OF PARTS	4
FRONT PANEL	4
REAR PANEL	5
RC4001PM REMOTE CONTROLLER	5
USING THE REMOTE CONTROL UNIT	6
BASIC OPERATION	7
OPERATION PROCEDURES	7
RECORDER OPERATION	7
TROUBLESHOOTING	8
OTHERS	8
SPECIFICATIONS & DIMENSIONAL DRAWINGS	9

A NOTE ABOUT RECYCLING



This product's packaging materials are recyclable and can be reused. This product and the accessories packed together are the applicable product to the WEEE directive except batteries.

Please dispose of any materials in accordance with your local recycling regulations.

When discarding the unit, comply with your local rules or regulations.

Batteries should never be thrown away or incinerated but disposed of in accordance with your local regulations concerning chemical wastes.

FEATURES

- New Design for Discrete Amplifier Circuits
- Improved and optimized the circuit design, parts and pattern wiring
- Input buffer Circuit for High S/N ratio and Channel separation
- New aluminum front panel and aluminum cap knob
- Dual Speaker Terminals 1 & 2
- Full REC Selector
- Active Filter type Tone Control circuit

BEFORE USE

This section must be read before any connection is made to the mains supply.

■ Equipment mains working setting

Your Marantz product has been prepared to comply with the household power and safety requirements that exist in your area.

PM4001 can be powered by 230V AC only.

■ Copyright

Recording and playback of any material may require consent. For further information refer to the following:

- Copyright Act 1956
- Dramatic and Musical Performers Act 1958
- Performers Protection Acts 1963 and 1972
- Any subsequent statutory enactments and orders

■ Do not locate in the following places

To ensure long-lasting use, do not locate the PM4001 where:

- Exposed to direct sunlight.
- Near to sources of heat such as heaters.
- Highly humid or poorly ventilated.
- Dusty.
- Subjected to mechanical vibrations.
- On wobbly, inclined or otherwise unstable surfaces
- Radiated heat is blocked such as in cramped audio racks.

To ensure proper heat radiatizN, ensure the below clearance from walls and other equipment.

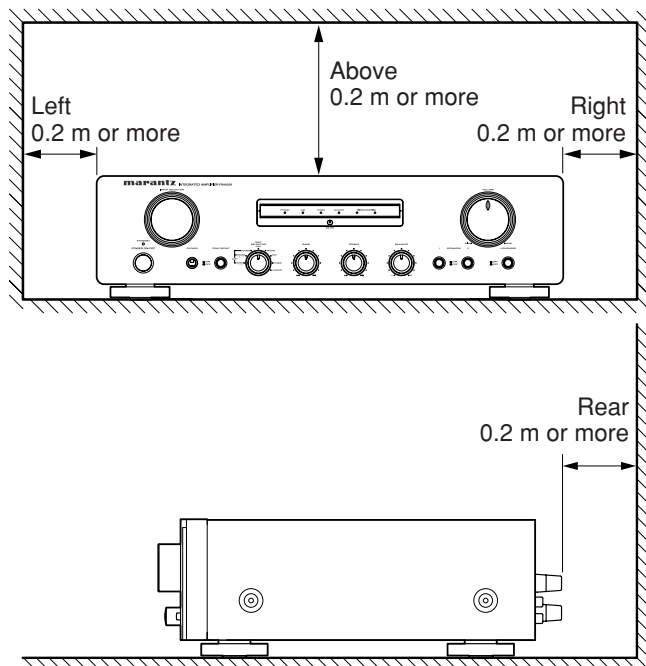

■ Keep objects off

Keep objects off the PM4001. Blocking the vent can result in accident and damage.

■ Do not touch hot spots during and Immediately after use

During and immediately after use, the PM4001 is hot in areas other than the controls and rear panel connection jacks. Do not touch hot spots and especially the top panel. Contact with hot areas can cause burns.

■ Battery handling

Improper use of dry cell batteries can result in electrolyte leaks, rupture and corrosion. Read the following precautions before use.

- If not planning to use the remote controller for an extended period of 1 month or more, remove the batteries.
- Do not mix old batteries with new batteries.
- Load batteries in the proper direction indicated on the remote controller.
- Do not mix batteries of differing type. Even batteries of the same shape and size can have differing voltages.
- If batteries leak, wipe the case clean of any adhering electrolyte and replace the old batteries with new batteries.

■ Accessories check

Before use, check the below accessories were included in the package.

- Remote control unit (RC4001PM)
- Size "AA" batteries x 2

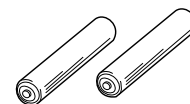
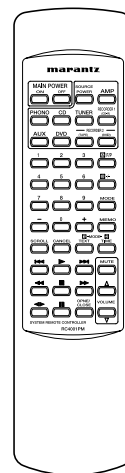

- User Guide
- Registration Card

CONNECTIONS

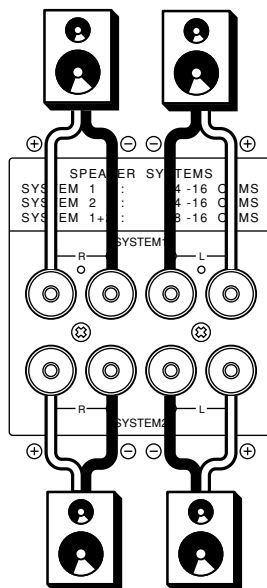
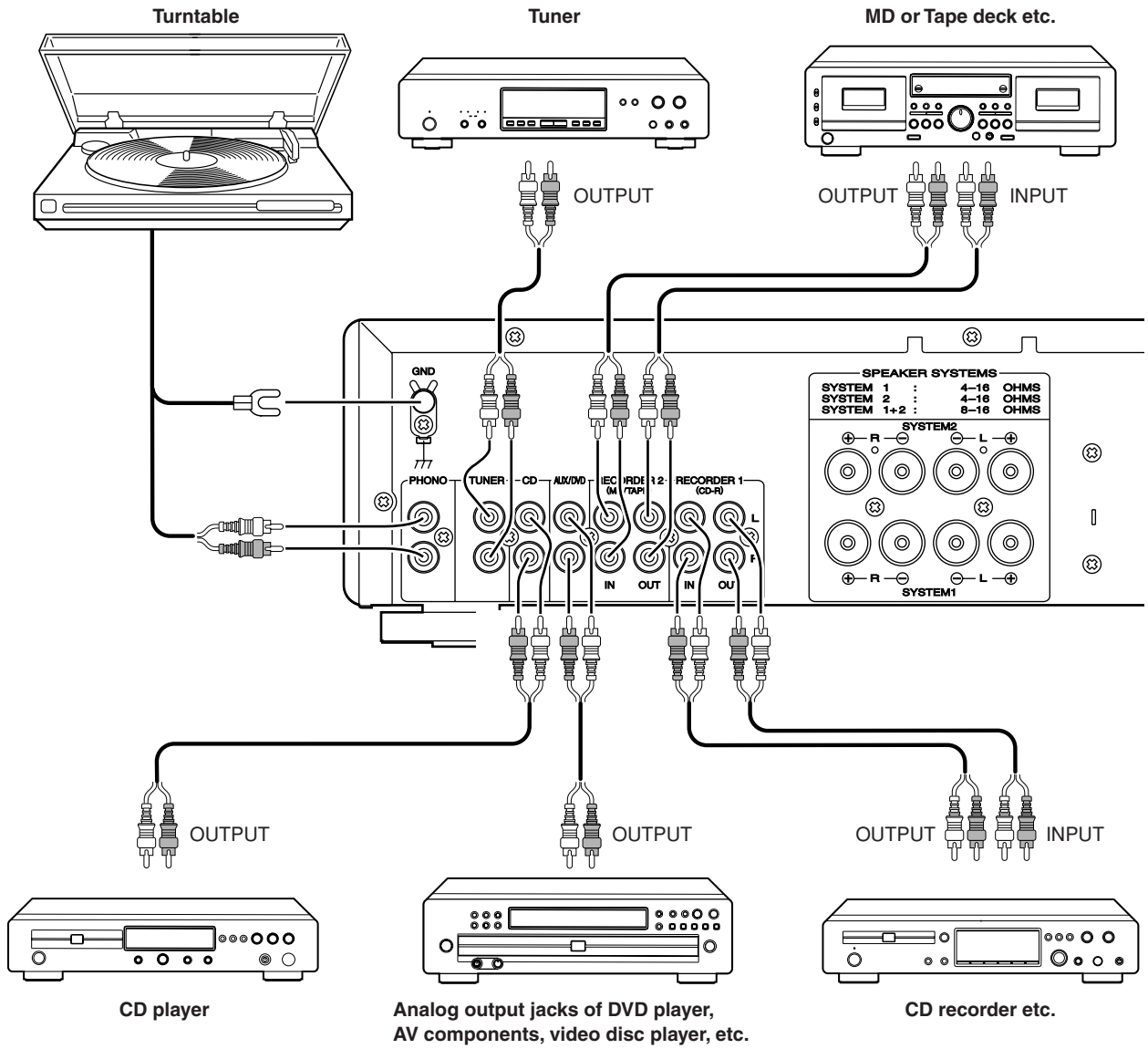

CONNECTIONS

CONNECTION OF TUNER

Connect the output jacks of your stereo tuner to the **TUNER** jacks of this unit.

CONNECTION OF COMPACT DISC PLAYER

Connect the output jacks of your CD player to the **CD** jacks of this unit.

CONNECTION OF TURNTABLE

Connect the L (Left) output cord of the turntable to the “**L**” **PHONO** jack of this unit, and connect the R (Right) output cord to the “**R**” **PHONO** jack. Also be sure to connect the turntable’s grounding wire to the **GND** jack of this unit. The **GND** jack does not have to be connected if the turntable is not provided with a grounding wire.

The cartridge of the connected turntable should be of the MM type. To use a turntable with an MC type cartridge, it is required to use a step-up transformer.

CONNECTION OF MD or TAPE DECK etc.

Connect the **IN** (recording input) jacks of the MD or tape deck to the **RECORDER 2 OUT** jacks of this unit, and connect the **OUT** (playback output) jacks of the MD or tape deck to the **RECORDER 2 IN** jacks of this unit.

CONNECTION OF CD recorder etc.

Connect the **IN** (recording input) jacks of the CD recorder to the **RECORDER 1 OUT** jacks of this unit, and connect the **OUT** (playback output) jacks of the CD recorder to the **RECORDER 1 IN** jacks of this unit.

CONNECTION OF SPEAKER SYSTEMS

This unit is equipped with two sets of **SPEAKER SYSTEM** terminals—**SYSTEM 1** terminals and **SYSTEM 2** terminals. Usually connect your speaker system to the **SYSTEM 1** terminals.

- The speakers in the speaker system should have an impedance between 8 and 16 ohms. If speakers with an impedance of less than 8 ohms are connected, the protection circuitry may be activated during play.
- Connect the Right channel speaker to the **R** terminals, and the Left channel speaker to the **L** terminals.
- The output terminals have positive (+: Red) and negative (–: Black) polarity, and each speaker also has the same polarity (+ and –). When connecting the speaker, be sure to connect the terminals with the same polarity (+ with +, – with –).

WIRING SPEAKER CABLE

- Be careful not to short circuit in wiring speaker cables.
- Peel off the coating of speaker cable as shown below.

Approx. 1 cm

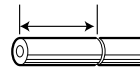

Cut the coating of cable.



Peel off the edge of cable.

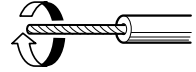

Twist conductors.

- Wiring with speaker cable.

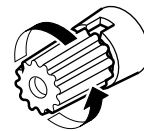

Turn counter-clockwise to loosen.

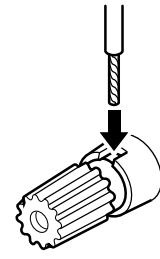

Insert conductor of cable.

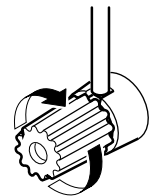

Turn clockwise to tighten.

NAMES AND FUNCTIONS OF PARTS

FRONT PANEL

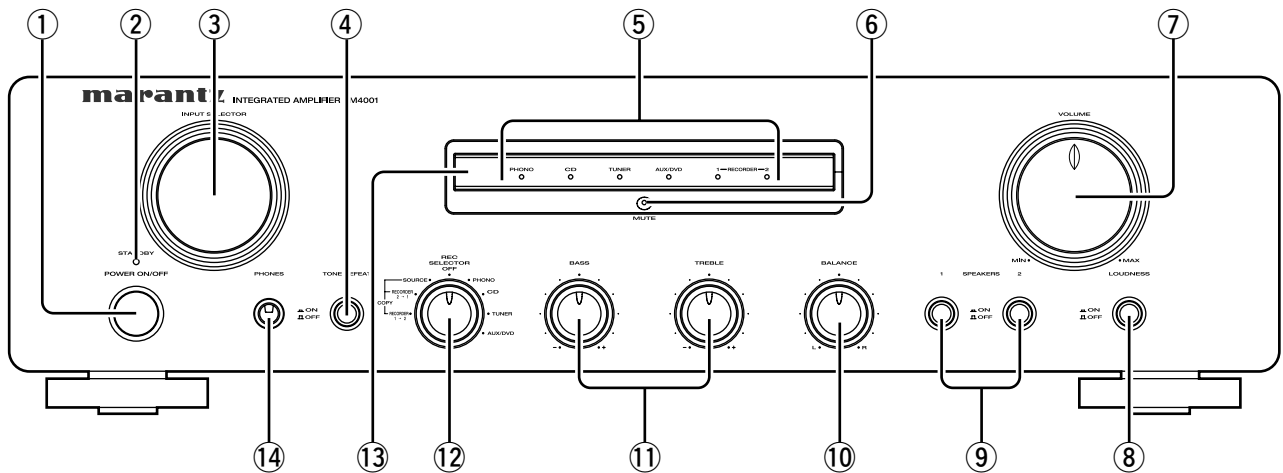

① POWER SWITCH

Pressing once switches the power ON, and pressing again switches it OFF.

If the **POWER** switch is in the ON position, the power of this unit can be turned ON/OFF by pressing the **POWER** button on the remote control unit.

② STANDBY INDICATOR

Lights up when the unit is in the standby mode.

③ INPUT SELECTOR

Selects the program source to be recorded or played from the **PHONO**, **CD**, **TUNER**, **AUX/DVD**, **RECORDER 1 (CD-R)**, and **RECORDER 2 (MD/TAPE)**.

④ TONE DEFEAT SWITCH

- When the switch is not depressed, the audio signals are applied to the tone control circuit and the tone can be adjusted using the tone control knob.
- When the switch is depressed, the audio signals bypass the tone control circuit and the balance control circuit. Then, the tone control knob and the balance control knob do not function.

⑤ FUNCTION INDICATORS

One of the indicators lights up to indicate the input source selected with the **INPUT SELECTOR**.

⑥ MUTING INDICATOR

Light up when the **MUTING** button in the remote control unit is pressed.

NOTE:

Be sure to check the **VOLUME** control setting before pressing this switch to cancel muting. If the muting is canceled while the volume setting is high, the speakers could be damaged.

⑦ VOLUME CONTROL

Adjusts the volume level. Turn the knob clockwise to increase the volume.

⑧ LOUDNESS SWITCH

The **LOUDNESS** switch compensates for human hearing characteristics by boosting the bass and treble response at low volume levels to achieve a more pleasing tonal balance.

⑨ SPEAKERS 1 / 2 SWITCHES

These switches are used to select the speaker system(s) connected to the **SPEAKER SYSTEM 1 / 2** terminals on the rear panel. If both the 1 and 2 switches are pressed to the low positions, two speaker systems can be used at the same time.

When headphones are used for listening, set both switches 1 and 2 to OFF (high positions).

⑩ BALANCE CONTROL

Turn the knob to correct an unbalanced program source such as stereo broadcast or to vary the output level of the left or right channel. Note that, if the **BALANCE** control is turned fully in one direction, the sound will not be heard from the speaker on the other side.

⑪ BASS AND TREBLE TONE CONTROLS

Adjusts the tone by controlling the levels of two frequency bands. Turn each control toward (+) to enhance the corresponding frequency band, or toward (-) to attenuate it.

TREBLE: Adjusts the high frequency level.

BASS: Adjusts the low frequency level.

⑫ REC SELECTOR SWITCH

Selects the tape dubbing mode between tape decks or the signal output at the **REC OUT** jacks.

⑬ REMOTE SENSOR

The remote sensor receives the infrared commands from the remote control unit. When an infrared signal is received from the remote control unit. The remote control unit must always be pointed directly at the remote sensor.

⑭ PHONES JACK

Insert the standard phone plug of the headphones into this jack.

NAMES AND FUNCTIONS OF PARTS

REAR PANEL

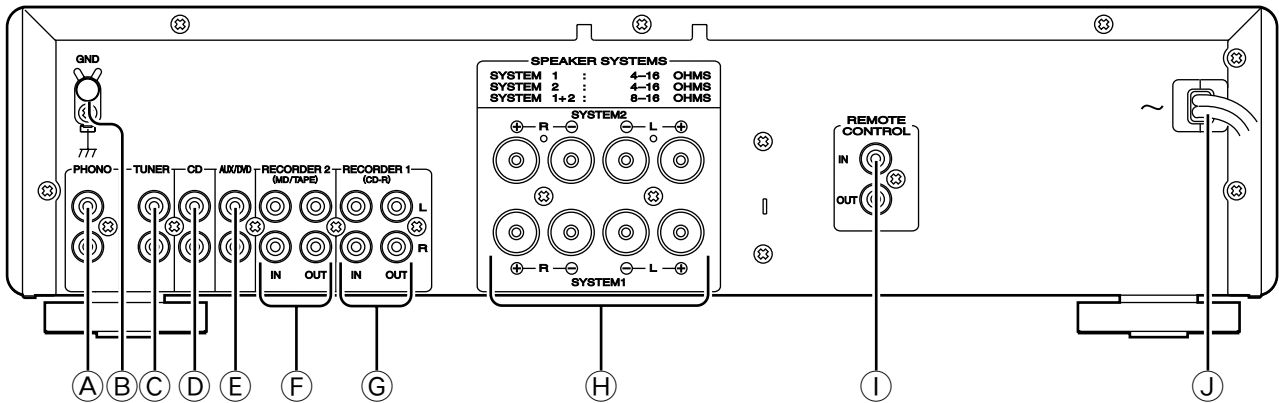

A PHONO INPUT JACKS

Connect the output jacks of a turntable to these jacks.

B GND (GROUND) TERMINAL

Connect the grounding wire from the turntable to this terminal.

C TUNER INPUT JACKS

Connect the output jacks of the tuner to these jacks.

D CD PLAYER INPUT JACKS

Connect the output jacks of a Compact Disc player to these jacks.

E AUX/DVD INPUT JACKS

These are auxiliary input jacks which can be used to connect the audio outputs of AV components such as DVD players, TV multiplex/stereo audio tuners, VCRs, and laserdisc players.

F RECORDER 2 (MD/TAPE) IN/OUT JACKS

Connect the play (output) jacks and record (input) jacks of MD or tape decks to these jacks.

G RECORDER 1 (CD-R) IN/OUT JACKS

Connect the play (output) jacks and record (input) jacks of CD Recorder to these jacks.

H SPEAKER SYSTEMS 1 / 2 TERMINALS

Connect your speaker system(s) to these terminals.

I REMOTE CONTROL BUS TERMINALS (REMOTE CONT. BUS)

Another item of audio equipment with a remote control bus terminal can be connected to these terminals by using a special-purpose cable. The bus **OUT** terminal is used to send signals to another item of equipment. The bus **IN** terminal is used to receive signals from another item of equipment.

J POWER CORD

Connect to a household power outlet.

RC4001PM REMOTE CONTROLLER

The RC4001PM can be used to control a Marantz AV component equipped with a remote sensor as well as other Marantz components connected to the first component through the Remote Control Bus. The buttons of the RC4001PM are laid out on its control panel according to the functional groups as described below.

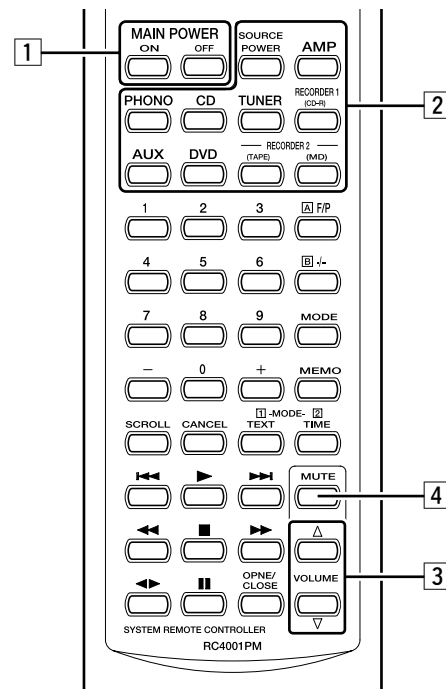

1 POWER ON/OFF buttons

a. MAIN POWER ON button

Turns the PM4001 power on when it is in the standby mode.

b. MAIN POWER OFF button

Sets the PM4001 power to the standby mode when it is set to the power-on mode.

NAMES AND FUNCTIONS OF PARTS

c. SOURCE POWER button

Switching the mode of a CD player, tuner, CD-R or other Marantz component equipped with a power standby function between power-on and standby is enabled by pressing this button after the **FUNCTION SELECT** button corresponding to the component has been pressed.

When this button is pressed after pressing the **TUNER** button, the tuner's power is turned on; when it is pressed again, the tuner is set to the standby mode.

When this button is pressed after pressing the **AMP** button, the PM4001 is switched from the power-on mode to the standby mode or vice versa.

2 FUNCTION SELECT button

PHONO button : When this button is pushed the input of PHONO is selected.

CD button : When this button is pushed the input of CD is selected.

TUNER button : When this button is pushed the input of TUNER is selected.

RECORDER 1

(CD-R) button : When this button is pushed the input of CD-R is selected.

AUX button : When this button is pushed the input of AUX/DVD is selected.

DVD button : When this button is pushed the input of AUX/DVD is selected.

RECORDER 2

(TAPE) button : When this button is pushed the input of MD/TAPE is selected.

(MD) button : When this button is pushed the input of MD/TAPE is selected.

CAUTION:

A pair of input jacks is used as the common input jacks for the MD or TAPE input and another pair is used as the common input jacks for the DVD or AUX input. The reason an independent button is used for each input is that the codes used by the RC4001PM to control the MARANTZ MD recorder, tape deck and DVD recorder are different.

3 VOLUME UP/DOWN button

UP button : **VOLUME** knob turns when this button is pushed and the volume level is grows.

DOWN button : **VOLUME** knob turns when this button is pushed and the volume level is falls.

4 MUTE button

When this button is pushed, the sound is not temporarily emitted from the speakers.

When this button is pushed again, MUTE is released. Moreover, when up/down of the volume is operated by remote control, MUTE is released.

Other buttons are not applied to PM4001.

Please see at the owners manual of other equipment's about the operation of button.

USING THE REMOTE CONTROL UNIT

Remote control

Operate the remote control unit within a distance of approx. 5 m from the infrared signal reception window (remote sensor) on the front of the Amplifier.

Remote control operation may not be possible if the remote control unit's transmitter is not pointing in the direction of the remote sensor or if there is an obstruction between the transmittete sensor.

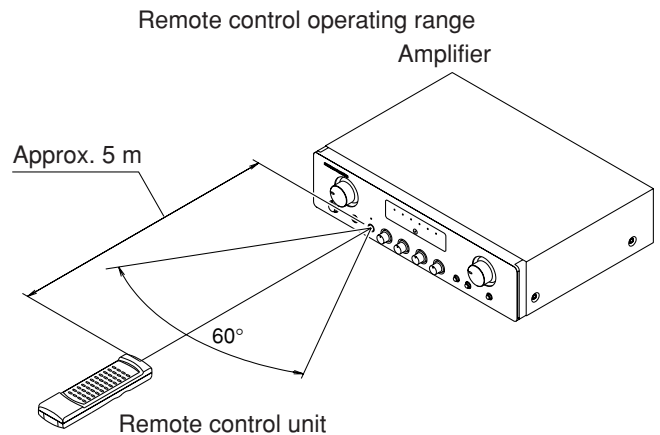

Loading batteries

Before using the supplied remote control unit for the first time, load the batteries in the remote control unit. The batteries provided are used to verify the operations of the remote control unit only.

(1) Remove the battery cover.

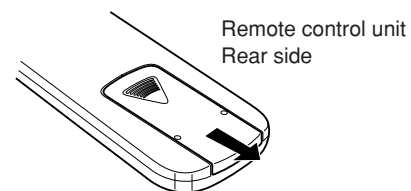

(2) Insert batteries with correct \oplus/\ominus orientation.

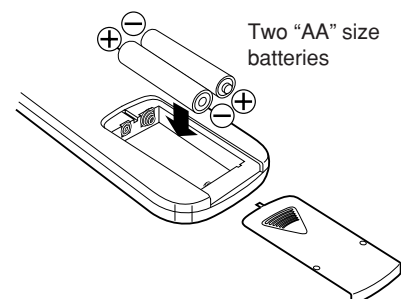

(3) Close the battery cover until it clicks shut.

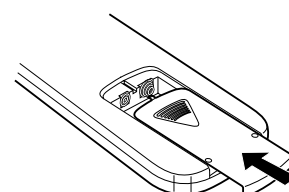

BASIC OPERATION

OPERATION PROCEDURES

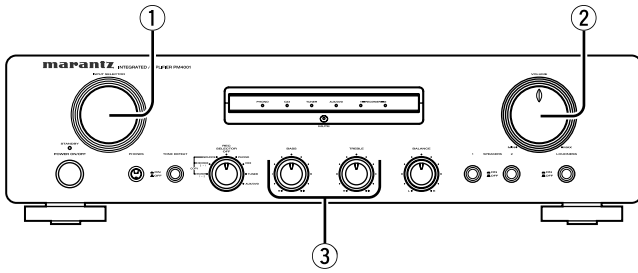

Operate each equipment to start play.

■ TO PLAY AN ANALOG DISC

1. Set the **INPUT SELECTOR** switch ① to **PHONO**.
2. Play a disc on the turntable.
3. Adjust the volume with the **VOLUME** control ② and adjust the tone with the **BASS** and **TREBLE** controls ③.

NOTES:

- Set the **VOLUME** control to the minimum position before placing the stylus on the disc or before replacing the cartridge.
- Do not apply shock or vibration to the turntable during play, as this may cause the stylus to jump and the analog disk to be damaged.
- If the turntable is installed too close to the speakers, the volume may not be able to be increased to a high level due to howling.
- Do not switch the power OFF while the stylus is on the disc surface.

■ TO LISTEN TO FM/AM BROADCASTS

1. Set the **INPUT SELECTOR** switch ① to **TUNER**.
2. Tune in the desired station on the tuner.
3. Adjust the volume with the **VOLUME** control ② and adjust the tone with the **BASS** and **TREBLE** controls ③.

■ TO PLAY A DVD OR COMPACT DISC

1. Set the **INPUT SELECTOR** switch ① to **CD**.
2. Play a CD on the CD player.
3. Adjust the volume with the **VOLUME** control ② and adjust the tone with the **BASS** and **TREBLE** controls ③.

■ TO PLAY A DVD OR COMPONENT CONNECTED TO AUX/DVD JACKS

The component connected to the **AUX/DVD** jacks on the rear panel can be played as follows.

1. Set the **INPUT SELECTOR** switch ① to **AUX/DVD**.
2. Play the component connected to the selected input.
3. Adjust the volume with the **VOLUME** control ② and adjust the tone with the **BASS** and **TREBLE** controls ③.

RECORDER OPERATION

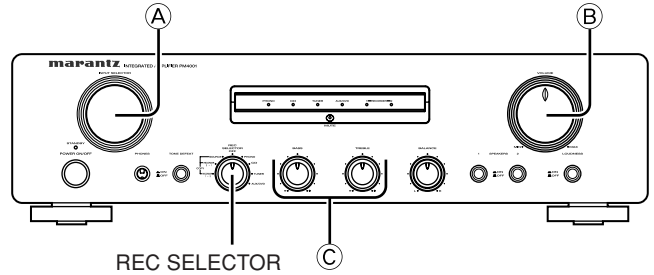

Control used for operating the tape deck.

■ PLAYBACK

1. Set the **INPUT SELECTOR** switch ① to **RECORDER 1 (CD-R)** or **RECORDER 2 (MD/TAPE)**.
2. Play a prerecorded disc or tape on the recorder.
3. Adjust the volume with the **VOLUME** control ②.
4. Adjust the tone with the **BASS** and **TREBLE** controls ③.

■ RECORDING

The playback sound of a program source component, such as a turntable, a tuner, or a CD player, can be recorded on disc or tape as follows.

1. Set the **INPUT SELECTOR** switch ① to the program source to be recorded.
2. Play the program source.
3. Operate the recorder(s) to record the playback sound on disc(s) or tape(s).

■ Using REC SELECTOR switch

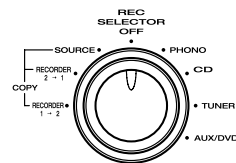

The **REC SELECTOR** switch is used when copying a recorded disc or tape to another disc or tape, or recording a CD onto a recordable disc or cassette tape.

1. When the switch is in the **OFF** position, the signal is not output at the **REC OUT** jacks. It is not necessary to output the signal at the **REC OUT** jacks when the signal is not recorded onto disc or tape. By setting the switch to **OFF**, the signal path inside the unit can be shortened and crosstalk, etc., can be reduced.
2. In the **SOURCE** position, the signal selected with the **INPUT SELECTOR** switch can be recorded onto disc/tape.
3. In the **COPY** positions, the **RECORDER 2 (MD/TAPE)** signal can be recorded onto **RECORDER 1 (CD-R)** or vice versa.
4. In the **COPY** position, the program source selected with the **INPUT SELECTOR** switch can be monitored through the speakers.

TROUBLESHOOTING

In case of trouble or abnormal operation of the unit, check the following before contacting service personnel. What may seem to be a serious malfunction is often the result of a simple operation mistake. If the trouble persists after checking the following, please contact your dealer or nearest Marantz distributor.

*** The amplifier does not operate and the indicators do not light.**

1. Check to see if the power cord is inserted properly into the power outlet.

*** The indicators light but the amplifier does not operate.**

1. Check to see if the **SELECTOR**, **SPEAKER** switches and **VOLUME** control are properly set.

*** Sound is heard from only one of the speakers.**

1. Check to see if the **BALANCE** control is properly set.
2. Switch the power of the unit to OFF, and change the connections of the left and right speaker cords. If the sound from the same speaker is still not heard, its connection cord or the speaker itself may be defective.

*** Considerable hum noise is heard when the turntable is played.**

1. Check to see if the plugs from the turntable are properly connected to the **PHONO** jacks.
2. Connect the grounding wire of the turntable to the **GND** terminal on the rear panel of this unit. If it has already been connected, try removing it.
3. Check to make sure that the phono cartridge is attached securely to the tonearm.
4. Unplug the power cord and plug it in again after inverting the orientation of the blades.

*** Remote control operation is not possible.**

1. Is the remote control unit's transmitter pointed correctly at the remote sensor on the front of the Amplifier?
Or, is there an obstruction between the transmitter and the remote sensor?
2. Are the batteries in the remote control unit exhausted?
3. Is there another strong light (from a window, etc.) striking the Amplifier remote sensor?
4. Is an RCA cord connected to the "REMOTE CONTROL IN" jack on the Amplifier rear panel?

OTHERS

The section describes the care and maintenance tasks that must be performed to optimize the operation of your Marantz equipment.

■ Cleaning of equipment external surfaces

The exterior finish of your unit will last indefinitely with proper care and cleaning. Never use scouring pads, steel wool, scouring powders or harsh chemical agents (e.g., lye solution), alcohol, thinner, benzene, insecticide or other volatile substances as these will mar the finish of the equipment. Likewise, never use cloths containing chemical substances. If the equipment gets dirty, wipe the external surfaces with a soft, lint-free cloth.

If the equipment becomes heavily soiled:

- dilute some washing up liquid in water, in a ratio of one part detergent to six parts water.
- dip a soft, lint free in the solution and wring the it is damp.
- wipe the equipment with the damp cloth.
- dry the equipment by wiping it with a dry cloth.

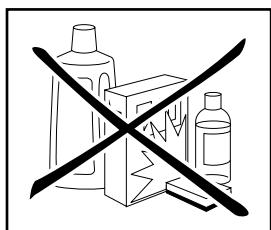

■ Repairs

Only the most competent and qualified service technicians should be allowed to service the factory-trained warranty station personnel have the knowledge and special facilities needed for repair and calibration of this precision equipment. After the warranty period has expired, repairs will be performed for a charge if the equipment can be returned to normal operation.

In the event of difficulty, refer to your dealer or write directly to the nearest location to you that is listed on the Marantz Authorized Service Station list. If writing, please include the model and serial number of the equipment together with a full description of what you think is abnormal about the equipment's behaviour.

SPECIFICATIONS & DIMENSIONAL DRAWINGS

Power output

RMS 8 Ohms / 4 Ohms (40 Hz – 20 kHz)	40 / 55 W
DIN 8 Ohms / 4 Ohms	45 / 60 W

IHF dynamic power

8 Ohms / 4 Ohms	55 / 80 W
THD at 8 Ohms RMS rated output	0.01%
Intermodulation distortion	0.01%
Damping factor	100

Magnetic cartridge input

Input sensitivity impedance	2.5 mV / 47 k ohms
Accuracy of frequency response to RIAA	0.5 dB
Signal to noise ratio	80 dB

Tuner / CD / AUX/DVD / RECORDER 1 / RECORDER 2 inputs

Input sensitivity impedance	170 mV / 20 k ohms
Signal to noise ratio	104 dB
Frequency response (-1 dB)	10 Hz – 50 kHz
Tone characteristic (100 Hz and 10 kHz)	±10 dB
Channel separation	70 dB

General

Power Requirements	
N, UK version	230 V AC, 50 Hz
Dimensions (MAX) (WxHxD)	440 x 117 x 341 mm
Weight	6.6 kg

Accessories

Remote control unit (RC4001PM)	1
AA type Batteries	2
Registration Card	1
User's Guide	1

Specifications subject to change without prior notice.

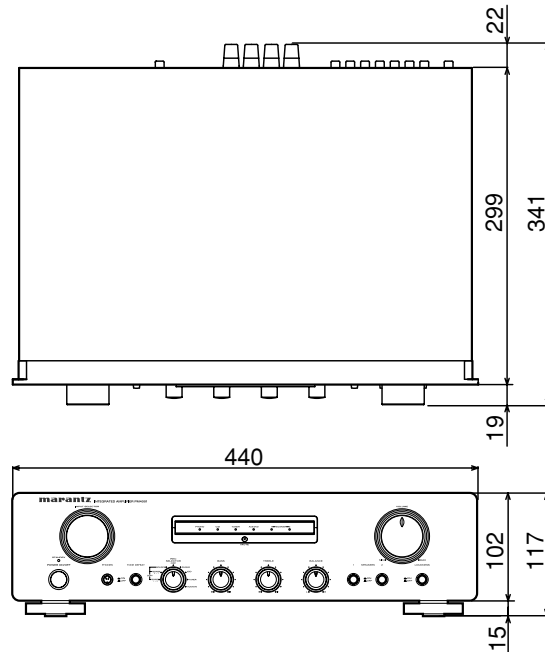

www.marantz.com

You can find your nearest authorized distributor or dealer on our website.

U.S.A. Marantz America, Inc. 1100 Maplewood Drive, Itasca, IL 60143, U.S.A.

EUROPE Marantz Europe B.V. P.O. Box 8744, 5605 LS Eindhoven, The Netherlands

marantz[®] is a registered trademark.

